

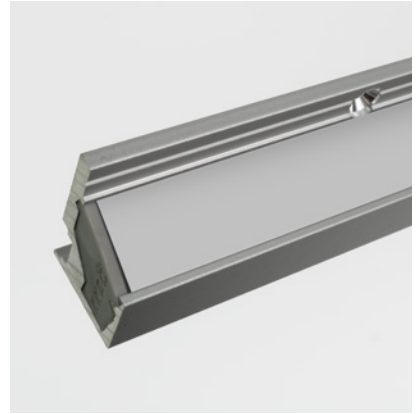

# TANA RGB Fixture Guide



Indoor | Surface | RGB output



### Key applications

- ✓ Architectural detail
- ✓ Cabinet & furniture
- ✓ Direct lighting
- ✓ Display case
- ✓ Interior
- ✓ Retail display
- ✓ Shelving display
- ✓ Special effect

### Key features

- ✓ Custom lengths
- ✓ Constant Voltage (CV)
- ✓ Continuous light runs
- ✓ Diffusion: homogenous
- ✓ IP40 dry area
- ✓ RGB

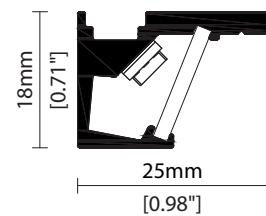

### FIXING METHODS



SF Screw fixing

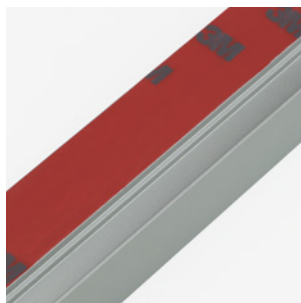

TF 3M tape fixing

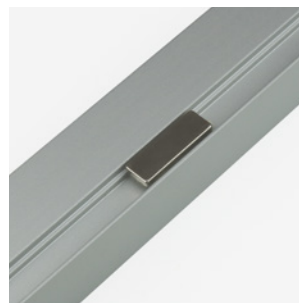

MF Magnet fixing

Linear

# TANA RGB

## Specification sheet



<b>Dimensions</b>	H18/W25/L103-2020mm (H0.71/W0.98/L4.05-79.53in)
<b>PCB Cut-point</b>	83.3mm increment/2000mm max (3.28in increment/78.74in max)
<b>LED Pitch</b>	13.9mm-72LED/m (0.55in - 22LED/ft)
<b>Chip</b>	RGB
<b>Cover/Optics</b>	Diffused (110°)/Clear @ 45 degree position (90°)/Clear @ 5 degree position (50°)
<b>CCT</b>	Red 620-625nm/Blue 455-460nm/Green 520-525nm
<b>LED binning</b>	5nm tolerance
<b>CRI</b>	N/A
<b>Lifetime</b>	50,000 hours @ 25°C (50,000 hours @ 77°F)
<b>Operating temp</b>	T <sub>a</sub> = -25 to 50°C (T <sub>C</sub> max = 83°C) T <sub>a</sub> = -13 to 122°F (T <sub>C</sub> max = 181.4°F)
<b>IP Rating</b>	IP40
<b>Finish</b>	Silver anodised
<b>Mounting</b>	Surface mounting via screw fixing, 3M tape or magnets
<b>Power feed</b>	Hardwire tails or male/female connectors
<b>Control</b>	DMX/DALI



Power consumption	Supply voltage	Supply current
15.6W/m (4.75W/ft)	24V DC	0.65A/m (0.20A/ft)

### Clear Cover

Red: 119lm/m (36lm/ft)  
Green: 257lm/m (78lm/ft)  
Blue: 42lm/m (13lm/ft)  
RGB: 372lm/m (113lm/ft)

### Diffused Cover

Red: 86lm/m (26lm/ft)  
Green: 186lm/m (57lm/ft)  
Blue: 31lm/m (9lm/ft)  
RGB: 269lm/m (82lm/ft)

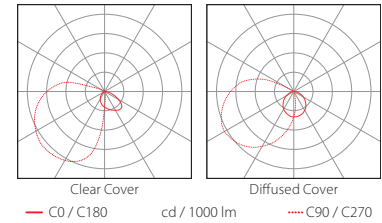
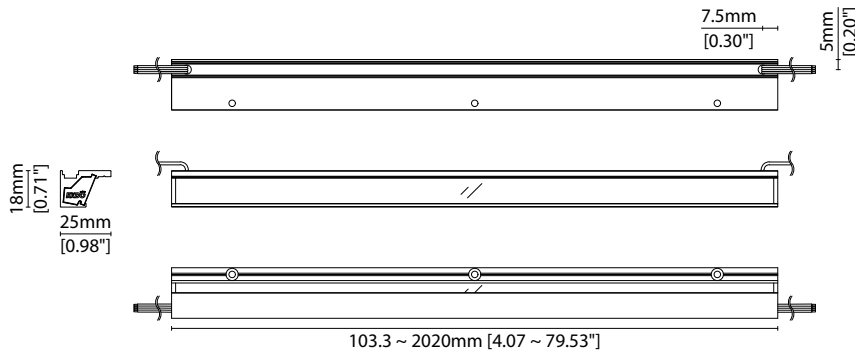

Data derived from IESNA LM-79-08 accredited testing of production samples.

### FIXTURE

Model	Finish	Cover <sup>1</sup>	Grade	LED	Colour	Length Availability <sup>2</sup>	IP	Cable Length	Power Feed <sup>3</sup>	Fixing <sup>4</sup>	LED Position	Input	
TANA TN	Silver Anodised SA	Clear B Diffused C	B s	501	RGB RGB	m 103.3-2020mm 83.3mm increments  i 4.07-79.53in 3.28in increments  (Specify length code OR total run length)	IP40 40	50mm/1.97"  1000mm/39.37"  3000mm/118.11"	0050  1000  3000	Single no sheath tail S00X  Double no sheath tail D00X  Single no sheath IP20 connector S20X  Double no sheath IP20 connector D20X	Screw SF 3M Tape TF Magnet MF	45° 45	DC 24V g

<sup>1</sup> Refer to **Cover Options** on **Options** pages

<sup>2</sup> Refer to **Length Availability List** or enter total run length instead of length code

<sup>3</sup> Refer to **Power Feed Options** on **Options** pages

<sup>4</sup> Refer to **Fixing Options** on **Options** Pages

### Code Example:

TN	-	SA	-	C	-	s	-	501	-	RGB	-	m	520	-	40	-	1000	-	S00X	-	SF	-	45	-	g
TANA		Silver Anodised		Diffused				501		RGB			519.8mm		IP40		1000mm/39.37"		Single no sheath tail		Screw		45°		DC 24V

### ACCESSORIES

#### Connection Accessories

KKCN-07	4 PIN RGB male & female 50mm (1.97in) pair
KKCN-09	4 PIN RGB male & female 300mm (11.81in) pair
KKCN-11	4 PIN RGB 300mm (11.81in) extension lead

#### PSU/Driver

DALI/DMX

\* Refer to **Driver/PSU Options** page for details or provide requirement and KKDC to offer the suitable option

\* Refer to **Power feed** on **Accessories** pages

### LED ENGINE VARIANTS (LED STRIP TYPE)

Colour	LED	Lumen/m	Lumen/ft	W/m	W/ft	Spec Doc	Length	Increment
Single CCT	R007	534	163	7	2.13	TANA R007	103-2020mm (4.05-79.53in)	41.7mm (1.64in)
	R014	1098	335	14	4.27	TANA R014	103-2020mm (4.05-79.53in)	41.7mm (1.64in)
	R020	1569	478	20	6.10	TANA R020	103-2020mm (4.05-79.53in)	41.7mm (1.64in)
	2 R014	1751	534	28	8.53	TANA2 R014	103-2020mm (4.05-79.53in)	41.7mm (1.64in)
Warm Dim/Dynamic White	R207	1221	372	16	4.88	TANA R207	103-2020mm (4.05-79.53in)	83.3mm (3.28in)
<b>RGB</b>	<b>501</b>	<b>Red 119 Green 257 Blue 42 RGB 372</b>	<b>Red 36 Green 78 Blue 13 RGB 113</b>	<b>15.6</b>	<b>4.75</b>	<b>TANA RGB</b>	<b>103-2020mm (4.05-79.53in)</b>	<b>83.3mm (3.28in)</b>

\* Performance data: clear cover, RGB

# TANA RGB

## Length Availability List

Length Code		Fixture Length <sup>1</sup>		LED Strip <sup>2</sup>		End Cap Dimension <sup>3</sup>		Wattage (W)	Output (lm)			
Metric	Imperial(US)	Metric	Imperial(US)	Metric	Imperial(US)	Metric	Imperial(US)		R	G	B	W
m0103	i0004	103mm	4.07in	83mm	3.28in	0mm	0.00in	1.30	3	7	4	9
m0187	i0007	187mm	7.35in	167mm	6.56in	0mm	0.00in	2.60	6	13	7	19
m0270	i0011	270mm	10.63in	250mm	9.84in	0mm	0.00in	3.90	9	20	11	28
m0353	i0014	353mm	13.91in	333mm	13.12in	0mm	0.00in	5.20	12	26	14	38
m0437	i0017	437mm	17.19in	417mm	16.41in	0mm	0.00in	6.50	15	33	18	47
m0520	i0020	520mm	20.47in	500mm	19.69in	0mm	0.00in	7.80	18	39	21	57
m0603	i0024	603mm	23.76in	583mm	22.97in	0mm	0.00in	9.10	21	46	25	66
m0687	i0027	687mm	27.04in	667mm	26.25in	0mm	0.00in	10.40	24	52	28	75
m0770	i0030	770mm	30.32in	750mm	29.53in	0mm	0.00in	11.70	27	59	32	85
m0853	i0034	853mm	33.60in	833mm	32.81in	0mm	0.00in	13.00	30	65	35	94
m0937	i0037	937mm	36.88in	917mm	36.09in	0mm	0.00in	14.30	33	72	39	104
m1020	i0040	1020mm	40.16in	1000mm	39.37in	0mm	0.00in	15.60	36	78	42	113
m1103	i0043	1103mm	43.44in	1083mm	42.65in	0mm	0.00in	16.90	39	85	46	122
m1187	i0047	1187mm	46.72in	1167mm	45.94in	0mm	0.00in	18.20	42	91	49	132
m1270	i0050	1270mm	50.00in	1250mm	49.22in	0mm	0.00in	19.50	45	98	53	141
m1353	i0053	1353mm	53.29in	1333mm	52.50in	0mm	0.00in	20.80	48	104	56	151
m1437	i0057	1437mm	56.57in	1417mm	55.78in	0mm	0.00in	22.10	51	111	60	160
m1520	i0060	1520mm	59.85in	1500mm	59.06in	0mm	0.00in	23.40	54	117	63	170
m1603	i0063	1603mm	63.13in	1583mm	62.34in	0mm	0.00in	24.70	57	124	67	179
m1687	i0066	1687mm	66.41in	1667mm	65.62in	0mm	0.00in	26.00	60	130	70	188
m1770	i0070	1770mm	69.69in	1750mm	68.90in	0mm	0.00in	27.30	63	137	74	198
m1853	i0073	1853mm	72.97in	1833mm	72.18in	0mm	0.00in	28.60	66	143	77	207
m1937	i0076	1937mm	76.25in	1917mm	75.47in	0mm	0.00in	29.90	69	150	81	217
m2020	i0080	2020mm	79.53in	2000mm	78.75in	0mm	0.00in	31.20	72	156	84	226

<sup>1</sup> Actual total overall length of light fixture (LED strip + end caps + void/wire hole)

<sup>2</sup> Actual length of PCB strip

<sup>3</sup> Actual length of 2x end caps

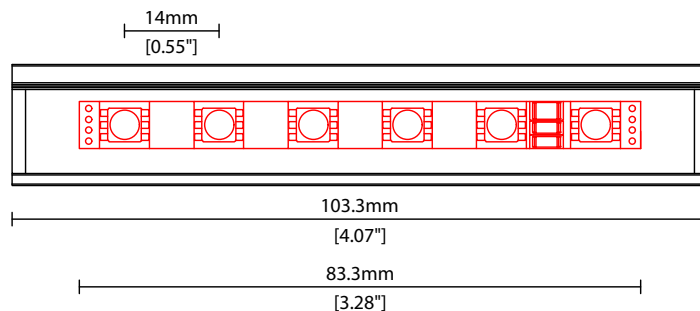

## LED POSITION OPTION

\* Options are an integral part of the fixture ordering codes. Please refer to **Code Table** pages.

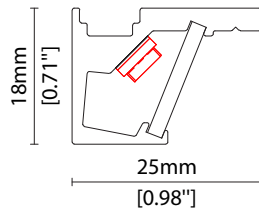
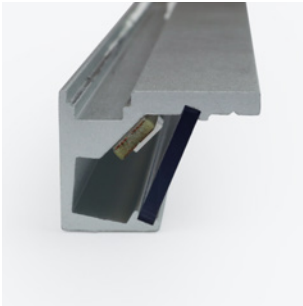

45 45° LED position

## COVER OPTIONS

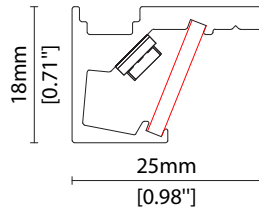

**B** Clear cover  
Polycarbonate

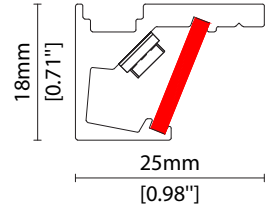

**C** Diffused cover  
Polycarbonate

## FIXING OPTIONS

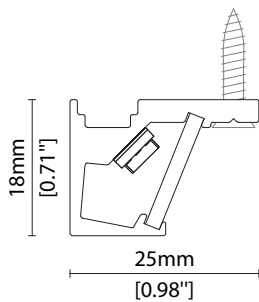

**SF** Screw fixing

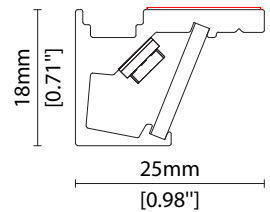
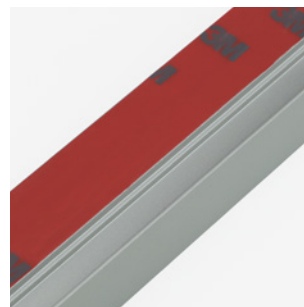

**TF** 3M tape fixing

## FIXING OPTIONS (CONTINUED)

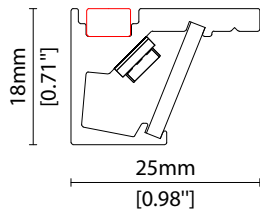

MF Magnet fixing

## POWER FEED OPTIONS

0050 S20X 50mm (1.97") Single IP20 connector

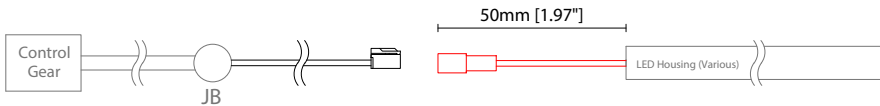

0050 D20X 50mm (1.97") Double IP20 connector

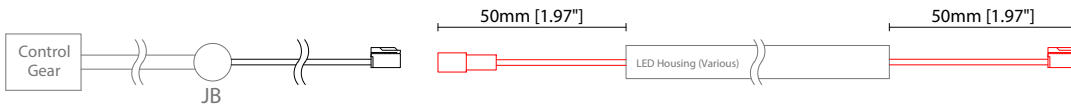

1000 S00X 1000mm (39.37") Single tail

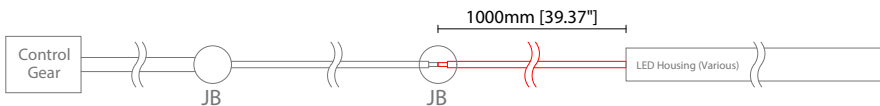

1000 D00X 1000mm (39.37") Double tail

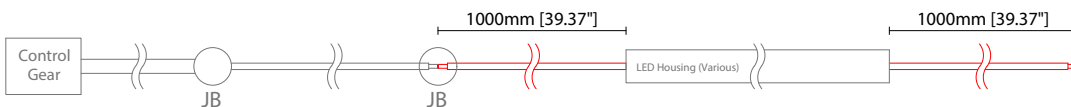

1000 S20X 1000mm (39.37") Single IP20 connector

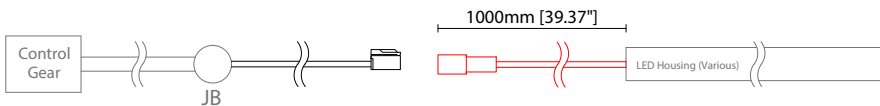

1000 D20X 1000mm (39.37") Double IP20 connector

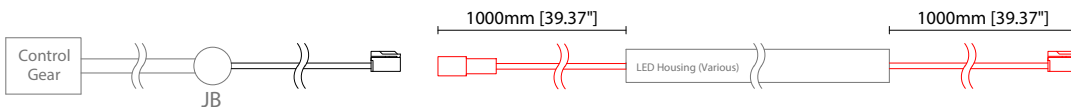

### Key

Control Gear Power supply, sub-controllers & control systems

JB Junction box / cable connection

## POWER FEED OPTIONS (CONTINUED)

### 3000 S00X 3000mm (118.11") Single tail

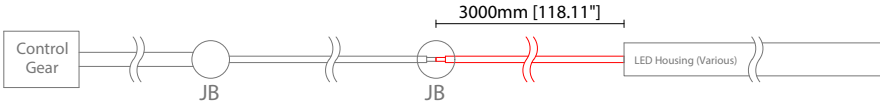

### 3000 D00X 3000mm (118.11") Double tail

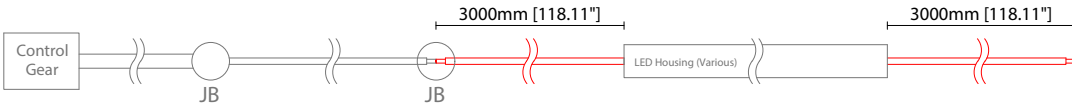

### 3000 S20X 3000mm (118.11") Single IP20 connector

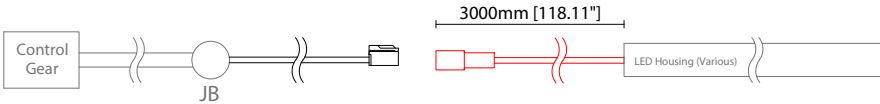

### 3000 D20X 3000mm (118.11") Double IP20 connector

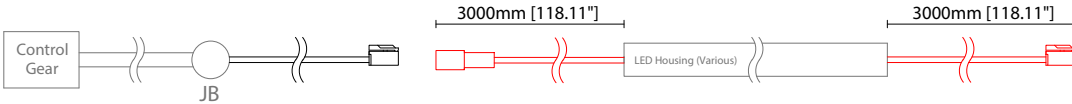

## 4 Pin RGB Female Connector

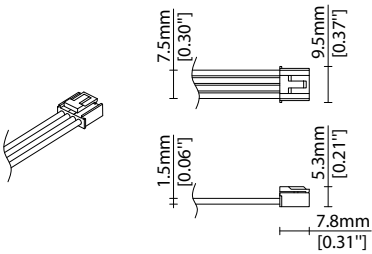

## 4 Pin RGB Male Connector

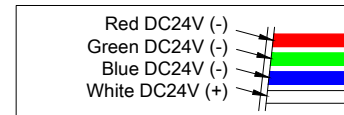
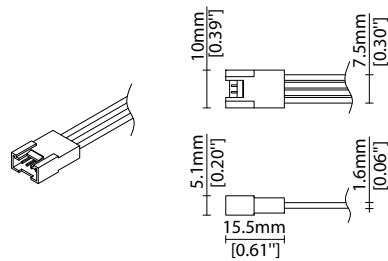

## Key

- Control Gear Power supply, sub-controllers & control systems
- JB Junction box / cable connection

## POWER FEED

Note: Accessories are to be ordered separately with corresponding code shown below.

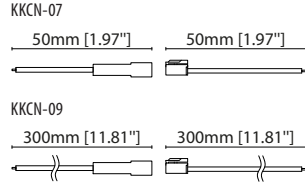
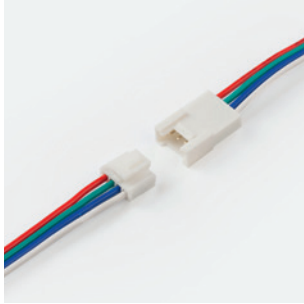

**KKCN-07** 50mm (1.97in) pair  
**KKCN-09** 300mm (11.81in) pair  
4 PIN RGB male + female  
connector set

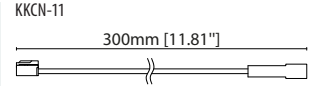

**KKCN-11**  
4 PIN RGB 300mm (11.81in)  
extension lead

## KKDC CONTROL



IP20  
Plastic housing  
L170/W59/H29mm  
(L6.69/W2.32/H1.14in)

**KKDM-06** 1-10V  
visDIM dimmable sub-controller  
(4 x 8A max @ 12-36V)



IP20  
Plastic housing  
L170/W53.4/H28mm  
(L6.69/W2.10/H1.10in)

**KKSC-05** DMX  
visDIM dimmable sub-controller  
(4 x 5A max @ 12-36V)



IP20  
Plastic housing  
L170/W59/H29mm  
(L6.69/W2.32/H1.14in)

**KKDL-02** DALI  
visDIM dimmable sub-controller  
(4 x 8A max @ 12-36V)



IP20  
Plastic housing  
L166/W53.4/H23mm  
(L6.54/W2.10/H0.91in)

**KKDL-03** DALI  
visDIM dimmable sub-controller  
(4 x 5A max @ 12-36V)



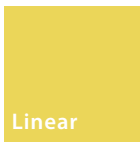

# TANA

## Driver/PSU Options



### AVAILABLE PSU OPTIONS

Control Mode	PSU (Order Code)	Input Voltage AC	Output Voltage DC	Rated Output Current	Rated Power	Dim %	IP Rating
Switched	CEN-60-24	90-295V	24V	2.5A	60W	-	IP67
	HLG-60H-24	90-305V	24V	2.5A	60W	-	IP67
	HLG-100H-24	90-305V	24V	4.0A	100W	-	IP67
	HLG-150H-24	90-305V	24V	6.3A	150W	-	IP67
	HLG-240H-24	90-305V	24V	10A	240W	-	IP67
0-10V (1-10V)	PWM-40-24	90-305V	24V	1.67A	40W	100-0.15 (100-10)	IP67
	PWM-60-24	90-305V	24V	2.5A	60W	100-0.15 (100-10)	IP67
	PWM-90-24	90-305V	24V	3.67A	90W	100-0.15 (100-10)	IP67
	PWM-120-24	90-305V	24V	5.0A	120W	100-0.15 (100-10)	IP67
DALI	LIN100A1	120-277V	24V	1A per channel	100W	100-0.1	IP66/IP40
DMX RGB	LIN100A1	120-277V	24V	1.33A per channel	100W	100-0.1	IP66/IP40
DMX RGBW	LIN100A1	120-277A	24V	1A per channel	100W	100-0.1	IP66/IP40

### Flicker Free Options - Combination of PSU+ sub-controller

Control Mode	PSU (Order Code)	Sub-controller (Order Code)	Input Voltage AC	Output Voltage DC	Rated Output Current	Rated Power	Dim %	IP Rating PSU/ Sub-controller
0-10V or 1-10V	CEN-60-24	KKDM-06	90-295V	24V	2.5A	60W	100-0.9	IP67/IP20
	HLG-60H-24	KKDM-06	90-295V	24V	2.5A	60W	100-0.9	IP67/IP20
	HLG-100H-24	KKDM-06	90-295V	24V	4.0A	100W	100-0.9	IP67/IP20
	HLG-150H-24	KKDM-06	90-295V	24V	6.3A	150W	100-0.9	IP67/IP20
	HLG-240H-24	KKDM-06	90-295V	24V	10.0A	240W	100-0.9	IP67/IP20
DALI	CEN-60-24	KKDL-02/03	90-295V	24V	2.5A	60W	100-0.1	IP67/IP20
	HLG-60H-24	KKDL-02/03	90-305V	24V	2.5A	60W	100-0.1	IP67/IP20
	HLG-100H-24	KKDL-02/03	90-305V	24V	4.0A	100W	100-0.1	IP67/IP20
	HLG-150H-24	KKDL-02/03	90-305V	24V	6.3A	150W	100-0.1	IP67/IP20
	HLG-240H-24	KKDL-02/03	90-305V	24V	10.0A	240W	100-0.1	IP67/IP20
DMX RGB	CEN-60-24	KKSC-05	90-295V	24V	2.5A	60W	100-0.9	IP67/IP20
	HLG-60H-24	KKSC-05	90-305V	24V	2.5A	60W	100-0.9	IP67/IP20
	HLG-100H-24	KKSC-05	90-305V	24V	4A	100W	100-0.9	IP67/IP20
	HLG-150H-24	KKSC-05	90-305V	24V	6.3A	150W	100-0.9	IP67/IP20
	HLG-240H-24	KKSC-05	90-305V	24V	10.0A	240W	100-0.9	IP67/IP20

<sup>1</sup> The items shown above cover the most frequently used specification but does not exhaust the possible options

<sup>2</sup> PSU and/or driver can be chosen from the table, or KKDC may recommend the best option upon receipt of the controls requirement and installation environment

<sup>3</sup> Electrical shop drawing will include detailed information of PSU and relevant control drivers

<sup>4</sup> Cut sheets are available on the controls section of [www.kkdc.lighting](http://www.kkdc.lighting) or upon request